

# Accessories for the Conde SDS 12



Item #2

Oil Catch Muffler

PN: MFOC3612

\$245.00

Item #6

SS. Pre-Filter

PN: LWTRPF150

\$340.00

Item #8

SS. Moisture Trap

PN: LWTRM01SS

\$340.00

Item #10

Primary Shut-Off Steel

PN:LWTRP02

\$235.00

Primary Shut-Off Alum.

PN: LWTRP01

\$275.00

Primary Shut-Off S.S.

PN:LWTRP03

\$275.00

Item #5, Vac/Press Gauge, PN:GAGE016, \$81.50

Item #7, Vacuum Relief Valve, PN:RV03, \$75.00

Item # 11, Pressure Relief Valve, PN:RVP13P, \$95.00

**TYPICAL TANK SET UP**

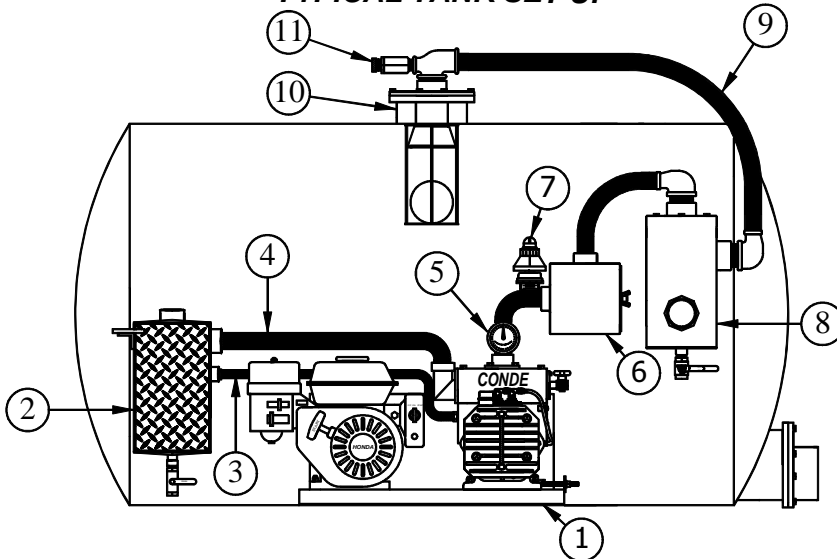

- 1 - CONDE VACUUM/PRESSURE GAS UNIT
- 2 - OIL CATCH MUFFLER
- 3 - PRESSURE VENT HOSE
- 4 - PUMP EXHAUST HOSE
- 5 - LIQUID FILLED VACUUM/PRESSURE GAUGE
- 6 - S.S. PRE-FILTER
- 7 - VACUUM RELIEF VALVE
- 8 - S.S. SECONDARY TRAP
- 9 - VACUUM/PRESSURE RATED HOSE
- 10 - PRIMARY TRAP
- 11 - PRESSURE RELIEF VALVE



**Save Money. Buy the complete accessory package including Primary Shut-Off, Oil Catch Muffler, Final Filter and Secondary Trap for \$900.00! PN:LWPKG1**

**\*Add \$40.00 for S.S. or Aluminum Primary**